











## 1200x1600 GOLEM

 mm		
1200	1600×1200	1600×3000

				
3×400 V	11,0	15-80	11650×80×1,6 (11650×67×1,6)	30350
L	B	Hmin	Hmax	V
5200	7653	3430	4100	745

\* doporučená hodnota. Při překročení doporučeného maximálního průměru není možné garantovat výkon pilového pásu!  
/recommended value. The blade performance cannot be guaranteed when the recommended diameter is exceeded!

 - řezání svazků bez horního přtlaku / cutting of the bundle without top clamping/

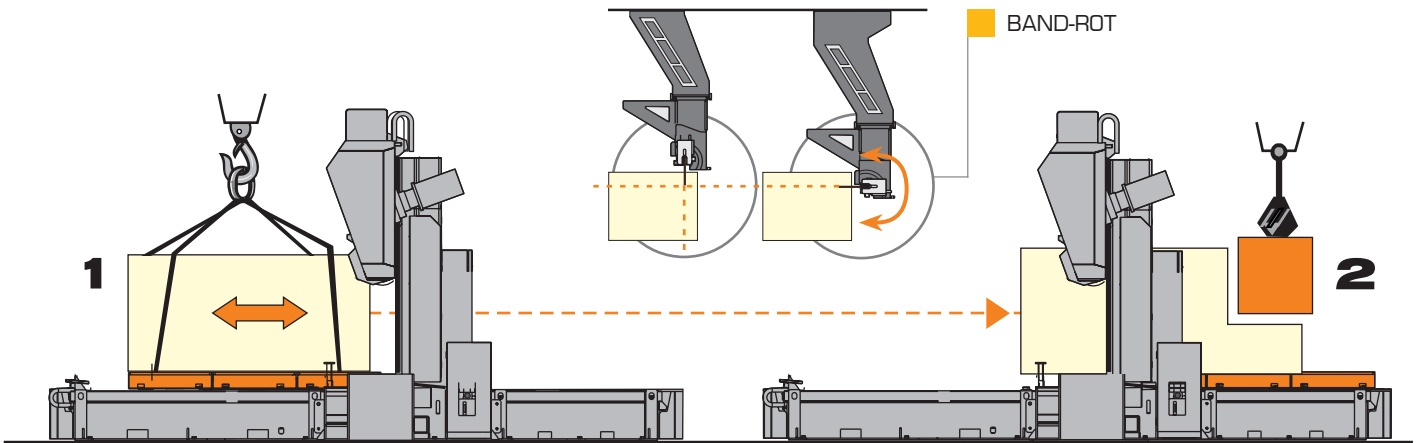
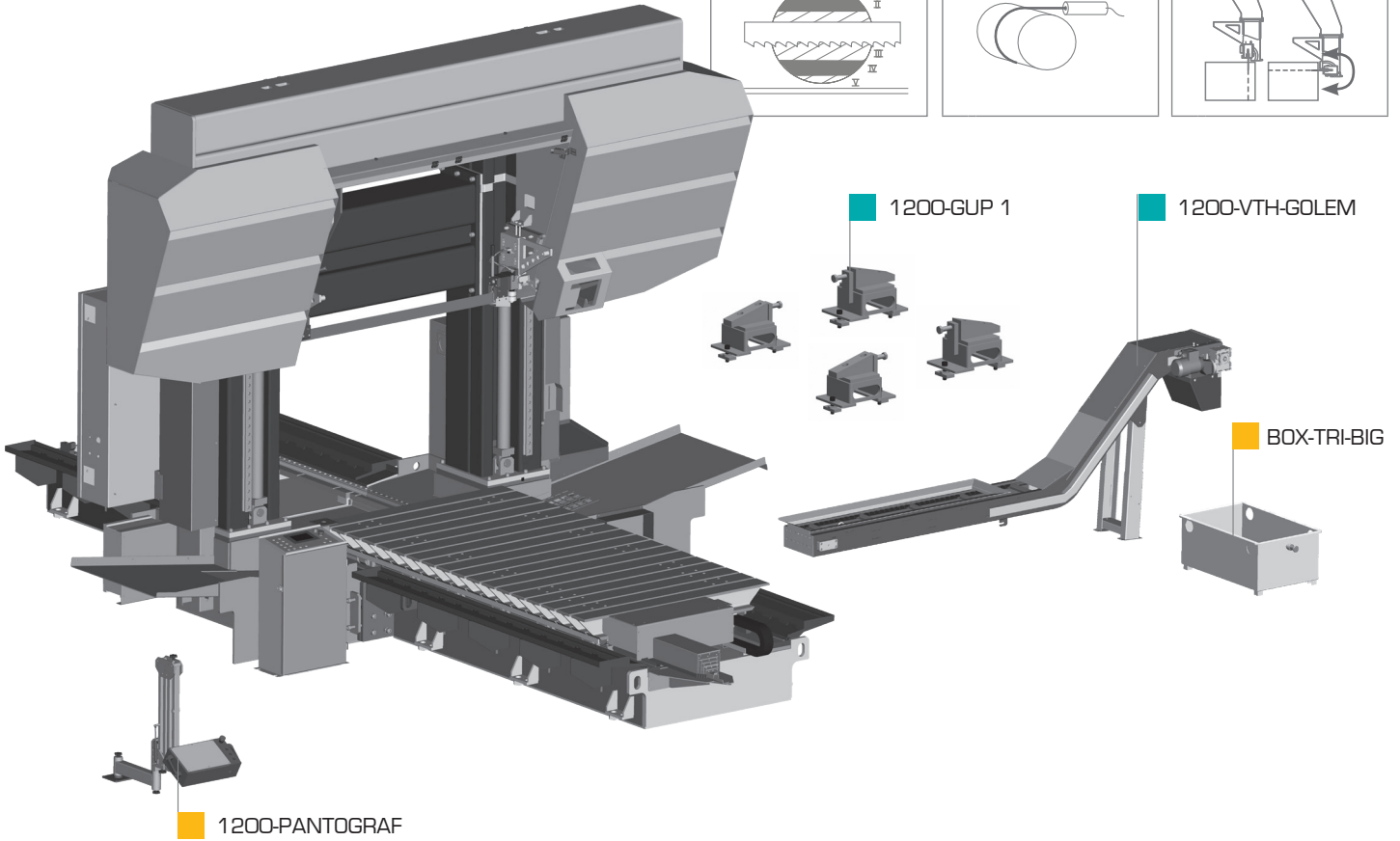
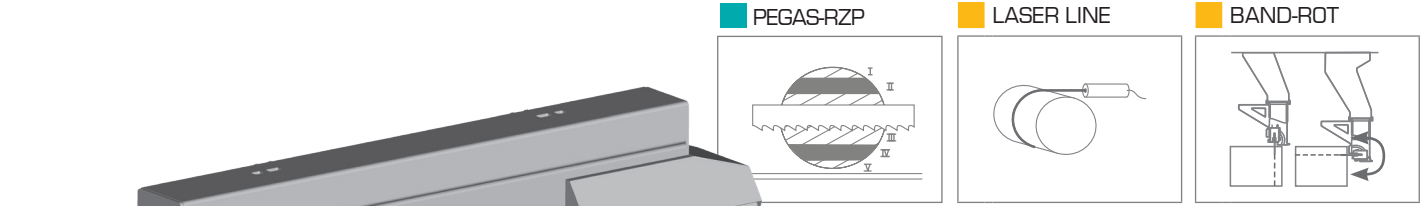
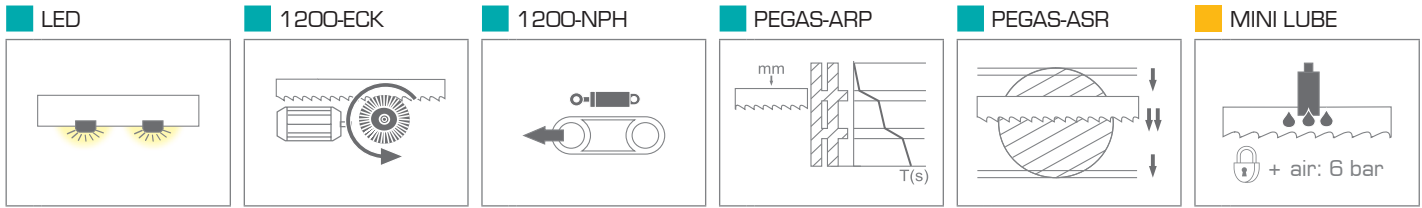

# 1200x1600 GOLEM

■ STANDARD ■ OPTION



PEGAS-GONDA s.r.o., Čs.armády 322, 684 01 Slavkov u Brna, CZECH REPUBLIC  
 Tel: 00420-544 221 125 (126), Fax: 00420-544 227 389, E-mail: pegas@gonda.cz  
 www.pegas-gonda.cz

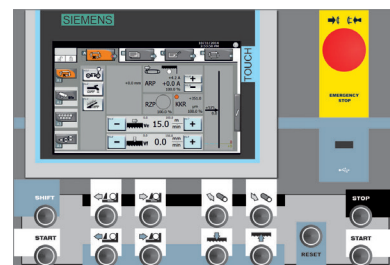

CONTROL PANEL: SIEMENS

- výrobce si vyhrazuje právo provádět změny technických údajů, technické údaje odpovídají 1.3.2018  
 / producer has the right to make changes of technical data, technical data are valid on 1.3.2018 /  
 - pila na fotografii není vždy v základním provedení, uvedené rozměry odpovídají stroji v základním provedení /  
 / the machine in the picture is not always in the basic version, mentioned diameters are for machine in basic version /